

Control panel types available on this model.

Type	Control Panel	Colour	Alarm	Tamper
A	Honeywell, Ademco Microtech	Green	1K	1K
B	Scantronic, Menvier, Pyronix PCX (12, 22, 44, 128 VID), Texecom, Castle CareTech G3 Plus.	Red	4K7	2K2
D	DSC	Orange	5K6	5K6
E	Guardtec	Purple	6K8	4K7
1*	Pyronix Matrix, PCX SMS, 134, 256.	Varies	4K7	4K7

* Please note that type 1 (4K7 : 4K7) is achieved by selecting the alarm link of type B and the tamper link of type E

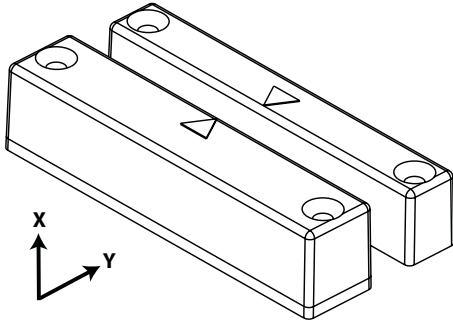

Approximate Operating Distances (mm) with reed closest to the arrow and using Non Ferrous Surfaces

X	Min Close	25mm
	Max Open	40mm
Y	Min Close	15mm
	Max Open	25mm

Mounting on a ferrous surface will reduce these figures, dependant on the material and thickness.

Specifications

Switch	Housing
Contact Material: Rhodium	Material: High Impact Polystyrene
Contact Rating: 500mA @ 12Vdc	Contact Dimension (mm): 65 x 13 x 15
Contact Resistance: 100 milliOhms	Contact Fixing (mm): 26mm centres
Temperature Range: -15° C to +40° C	Magnet Dimension (mm): 65 x 11 x 13
Life Expectancy: >1,000,000 cycles	Magnet fixing (mm): 26mm centres

Environmental Advice.

This product is covered by current WEEE regulations. Please consider the effect on the environment when disposing of it. Do not put in a domestic waste bin. Only dispose of at an appointed recycling centre.

4



RoHS compliant.

This product is designed to meet the requirements of EN50131-2-6:2008 Security grade 2, environmental class II

SC517/* /MULTI/G2/EN Magnetic Surface Contact.



* colour varies

Surface mounted magnetic contact.

Compact design

Four terminals.

Double pole or EOL configuration.

Suitable for domestic and commercial alarm circuits.

Suitable for double door applications.

Can be used in installations up to and including grade 2.

High impact polymer construction.

Operating and Installation Instructions

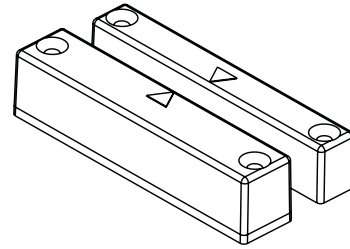

Description

This compact surface mounted magnetic contact can be used in most security systems up to and including grade 2 as specified in EN50131-1:2006 and is certified to EN50131-2-6:2008 and environmental class II (for use indoors) by Telefication. It operates as a normally closed circuit going open when the magnet housing is moved away from the contact housing. This contact can be used on windows and doors to detect the unauthorised entry of an intruder. A number of applications are shown over. The contact is also tamper protected against removal from its mounting surface.

CQR Security, 125, Pasture Road, Moreton, Wirral, CH46 4TH, United Kingdom

Tel: +44 (0) 151 606 9595 Support: +44 (0) 151 606 6311 email: info@cqr.co.uk Web http://www.cqr.co.uk

1

SC517/* /MULTI/G2/EN Issue 03

Features

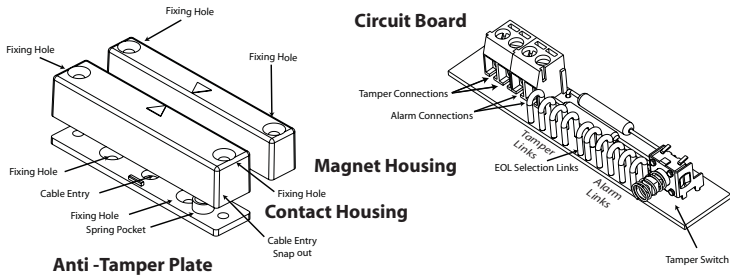

Suitable Applications and Fixing Points

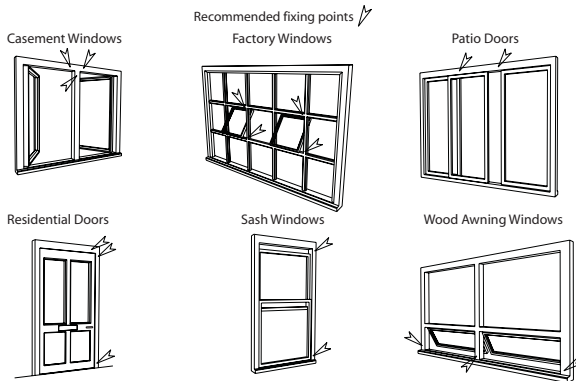

Mounting Instructions

Mount the contact housing using the fixing holes as shown in the diagram. Please see the mounting configurations to ensure that the contact is mounted in the most suitable location. Terminate the pcb as shown in the diagrams and cut the appropriate links. Refit the pcb into the casing with the pcb nearest to the arrow and the tamper switch facing outwards, this will ensure maximum operating gap. The separate anti tamper plate must be secured to the mounting surface with its own screws before the main case is fitted and finally secured into place. Mark out the position of the magnet housing and secure in place with the screws provided.

2

Mounting Configurations

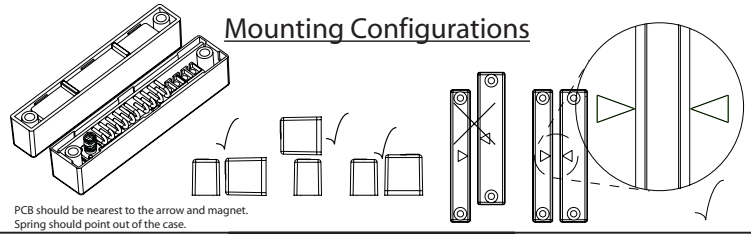

PCB should be nearest to the arrow and magnet.
Spring should point out of the case.

Wiring Configurations

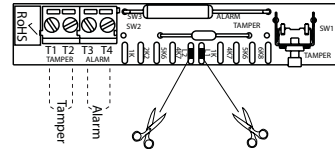

Double Pole

Cut links L1 and L2
Alarm Circuit = T3 and T4
Tamper Circuit = T1 and T2

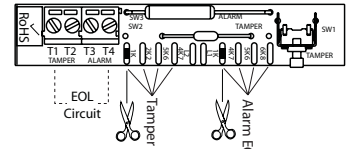

Fully Supervised (Panel type A illustrated)

Cut appropriate resistor links
(1K 1K illustrated).
EOL Circuit = T1 and T4

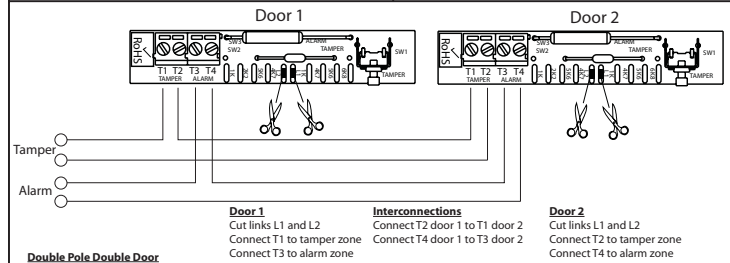

Double Pole Double Door

Door 1

Cut links L1 and L2
Connect T1 to tamper zone
Connect T3 to alarm zone

Interconnections

Connect T2 door 1 to T1 door 2
Connect T4 door 1 to T3 door 2

Door 2

Cut links L1 and L2
Connect T2 to tamper zone
Connect T4 to alarm zone

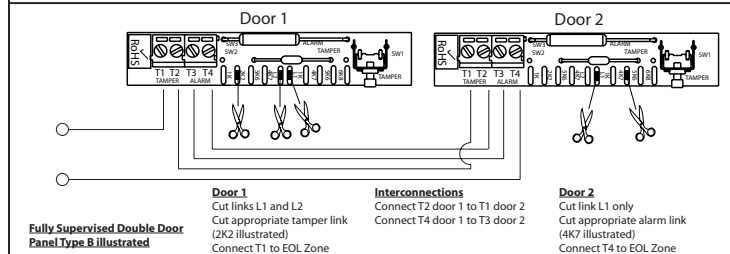

Fully Supervised Double Door Panel Type B illustrated

Door 1

Cut links L1 and L2
Cut appropriate tamper link
(2K2 illustrated)
Connect T1 to EOL Zone

Interconnections

Connect T2 door 1 to T1 door 2
Connect T4 door 1 to T3 door 2

Door 2

Cut link L1 only
Cut appropriate alarm link
(4K7 illustrated)
Connect T4 to EOL Zone

3